

UNICOL[®]

Supporting You

ISSUE 17

TRACOR EUROPE

Tél: 01.60.91.42.49

infocom@tracor-europe.fr

www.tracor-europe.fr



ROBUST, VERSATILE AND DEPENDABLE SUPPORT EQUIPMENT

With a product range of over 55,000 items and a speedy ex stock delivery service, UNICOL leads the field in the design and manufacture of mounting solutions for audio visual and video equipment.

– Visit our web site www.unicol.de or call us for advice on any project or item you may require.



SPECIAL PRODUCTS DIVISION

Our factory has an impressive array of manufacturing facilities with skilled personnel backed by over forty years of AV Industry experience.

Alongside our standard products we offer an efficient service in the manufacture of one-off and custom made items and can turn round orders for these within a day or so at prices which compare favourably with volume products.

– Call us for advice without obligation when planning your next installation!



Colour choice  Black or Silver
 Black standard Silver optional.
 (State colour choice when ordering)

Avecta®

A flexible and adaptable Plasma and LCD TV stand system designed for professional use to harmonise with the best interiors.

Superior, high quality range with many advanced features.

Height adjustment for screen, platform or cabinet units.

Full cable management with integrated 4-way power socket.

Twin screen units available for video conferencing and other uses.

How to Order

Select Avecta version required.

State make & model of Plasma or LCD TV. Standard colours Sinterflex Black or Diamond Silver.

Price includes Plasma / LCD mount, equipment platform & power socket.

Screens 51" - 65" require heavy-duty mounts (surcharge). (Not available for AVHTTE).



Height to centre of screen adjustable from 126 to 151cm

These products are the subject of UK and European design rights. Registered designs 2103583 & 2103584.

Avecta Hi-level Trolley
 Order Code AVHTE

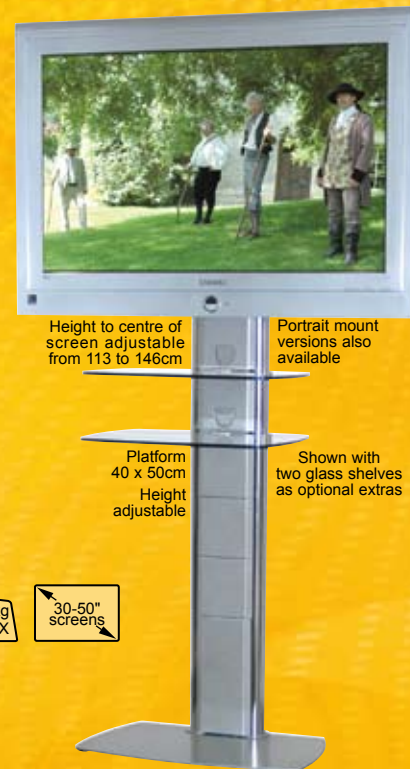

Height to centre of screen adjustable from 113 to 146cm

Portrait mount versions also available

Platform 40 x 50cm
 Height adjustable

Shown with two glass shelves as optional extras



Avecta Hi-level Stand
 Order Code AVHPE



Height to centre of screen adjustable from 126 to 151cm

Avecta Twin-screen Trolley

The twin screen Avecta trolley can support 32" to 50" screens. Comes with one AVP1 shelf for Lap Top or Video Conferencing Unit and one VCM platform for above screen installations. Extra shelves can be fitted. Includes 2 Universal mounts.

Colour Sinterflex Black (Diamond Silver to order).

Order Code AVHTTE

Avecta Cabinet Unit

The AVR1 Cabinet Unit is designed for any existing Avecta Hi-level system. It has three adjustable shelves and a clear polycarbonate panel in the door.

Free-standing version is also available - see P14. Colour Sinterflex Black (Diamond Silver to order).

Order Code AVR1



Height to centre of screen adjustable from 63 to 94cm

Avecta Lo-level Stand
 Order Code AVLP

Avecta Lo-level Trolley

Order Code AVLTE (not illustrated)

Similar to AVHTE Trolley illustrated. Height to centre of screen 76 to 107cm

Locking Cabinet

Height adjustable. Door conceals into roof. Useable top surface.



Cable access ports

Order Code AVLC
 Inside dimensions cm
 50 wide x 40 deep x 14 high



Equipment Platforms

Height adjustable. Design allows VCR / DVD cables to feed directly into mast.



Order Code	Size cm
AVP1	40 x 50
AVP2	45 x 55
AVP3	30 x 30



Toughened Glass Version

AVGS 40 x 50



Video Conferencing Mounts

Standard platform unit fits above Plasma or LCD screen. Use standard shelf when fitting below screen.

Other units available to fit specific Video Conferencing models.

- Call us for details.

Order Code VCM

State Video Conferencing Unit when ordering.

Unit fits behind Plasma or LCD. Can be extended to suit different screen sizes.

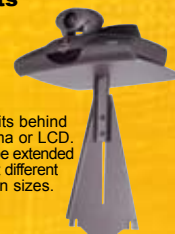

Platform size 26 x 34cm

Colour choice  Silver or Black
 Silver standard Black optional.
 (State colour choice when ordering)

Axia[®] the new artform in plasma stand design

With its emphasis on sleek design and flowing form, the Axia range adds style from the home to the boardroom and anywhere in between.

- Graceful and stylish design.
- High quality safety glass shelves. *
- Neat cable management within mast.
- Integrated 4-way power socket.
- Video conferencing options.
- Twin screen version available.

These products are the subject of UK and European design rights. Registered designs 3012115, 3012116, 3012117, 3012119. Patent No. GB2401784

Portrait mount versions also available



AX1500T

Height to centre of screen 161cm

How to Order

Select Axia version required.
 State make & model of Plasma or LCD TV. Standard colour Diamond Silver (Sinterflex Black to order).
 Price of all Axia versions includes Plasma or LCD mount and built in 4-way power socket.
 Lo-level Axia includes one AXGS glass shelf. (For shelves on Hi-level versions please order separately).
 Screens 51" - 65" require a heavy duty mast and screen mount. Height is restricted to 120cm. See below for details.



AX1000P

Height to centre of screen 100cm

Height adjustable

(* Glass Shelf AXGS included with Lo-level Stand and Trolley only)

Axia Lo-level Stand

Order Code AX1000P

Axia Lo-level Trolley

Order Code AX1000T



AX1500P

Height to centre of screen 150cm

Options for screens 51" to 65"

(shelf not included)

Order Code
 AX1200P Stand
 AX1200T Trolley



AX1500LC

Height to centre of screen 165cm.

Axia Hi-level Stand

Order Code AX1500P

Axia Hi-level Stand & Cabinet Base Unit

Order Code AX1500LC



Axia Hi-level Trolley

Order Code AX1500T

Safety Glass Shelves

Choose from 2 sizes, these high quality shaped and fully edge polished 8mm plate glass shelves are fully toughened and conform to BS 6206 Class A.

Use 1, 2 or 3 shelves on any Axia version.



Order Code AXGS
 Size 40 x 50cm



Order Code AXWS
 Size 39 x 78cm

Video Conferencing Mounts

Standard platform unit fits above Plasma or LCD screen. Use standard shelf when fitting below screen.

Other units available to fit specific Video Conferencing models.

- Call us for details.

Order Code VCM

State Video Conferencing Unit when ordering.

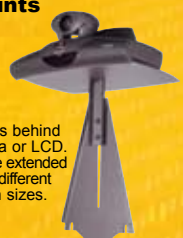

Unit fits behind Plasma or LCD. Can be extended to suit different screen sizes.

Platform size 26 x 34cm

Azana® Flatscreen TV Swivel Stand

Colour choice Silver standard Black optional.
(State colour choice when ordering)

Infinitely better than ordinary fixed stand units. The smooth swivel action of the screen mount allows viewing from any angle – perfect in flexible seating areas and easy to adjust to minimise reflections from windows or lighting. The swivel action also gives ready access to the rear of the screen for cabling.



- Smooth swivel action for optimum viewing.
- High quality design for the best in home cinema.
- Twin generously sized toughened glass shelves.
- Neat cable management within mast.
- Integrated 4-way power socket.
- Universal Screen Mount included.

Height to centre of screen 88cm



State make & model of Plasma or LCD TV.
Standard colour Diamond Silver
(Sinterflex Black to order).

Azana Lo-level Stand
Order Code
AZ1000



Universal Mount Table Stand

Unit incorporates our POZIMOUNT PZX universal mount (see Page 7) to fit a wide range of Plasma or LCD makes & models up to 65 inch screen size.

Neat 'Curve Style' base has non-marking resilient feet.
Centre pillar provides concealment for cables.

Please state your Plasma / LCD make & model to enable us to provide the correct fixing kit.

Order Code
PFT/PZX



Versions for large screens incorporating special mount.

Order Code
PFL 51" - 65"



Please state your Plasma / LCD make & model



Height to centre of screen 100cm

TEVELLA™ LCD TV Stand

EU Registered Design
000067319-0001

- For screens up to 30inch.
- Mounts available for most makes & models of LCD TV.
- Mains and other cables conceal within column.
- Screen can be tilted for optimum viewing angle.
- Base unit finished in Diamond Silver (Sinterflex Black to order).
- Column in polished chrome.



Order Code
TVA1000

State LCD TV make & model



Colour choice  Silver or Black
 Silver standard Black optional.
 (State colour choice when ordering)

Parabella

The inspirational stand system for exhibitions and conferences

The slender curving style of these units give dramatic effect to Plasma or large LCD displays.

There are two Parabella models. The Hi-level version for normal screen use and the Lo-Level 'lectern style' version for gallery, museum, exhibition information or touch screen display.

- Higher than normal screen position.
- Curved slim design.
- Neat cable management within legs.
- Glass shelf options.
- Built in four-way power socket with shelf option.
- Screen Mount included.

These products are the subject of UK and European design rights.
 Registered design 3012116
 Patent No. GB2401784

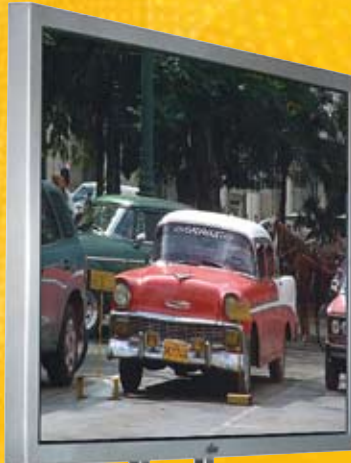

Hi-level stand



Hi-level stand with optional glass shelf and 4-way power socket

6ft high (183cm) to centre of screen



100cm to centre of screen

Lo-level lectern style stand



- Order Code
- PARA2000 Hi-level (up to 65" screens)
 - PARA1000 Lo-level 'lectern style'
 - PARAGS Safety Glass Shelf
 - PARAES4E Europlug Socket version *

* to be used only in connection with PARAGS

Please state Plasma or LCD make & model.
 Standard colour Diamond Silver (Sinterflex Black to order).



Colour choice  Silver or Black
 Silver standard Black optional.
 (State colour choice when ordering)

Light Duty VESA Range

For LCD TV screens with 75 x 75 and 100 x 100mm VESA fixings. (VESA mount standards are common on the back of many screens).

 8kg MAX
 13-21" screens

Slim-line wall Mount
 Order Code
 LVC

 20kg MAX



Tilt Mount
 Order Code
 LVA Black Only



Tilt & Swivel Mount
 Order Code
 LVB Silver Only



Standard VESA Range

In wall, ceiling and stand mounting versions. The range fits the widely adopted VESA standard matching holes on the back of the screen as detailed below. We also offer non-VESA mount versions for most makes & models of screens.

EU Registered Design 000325840-0001



Clip-On Slim-line Wall Mount
 Our most popular mount, easy to use, fits most screens. Concealed screw fixing for added security.
 Order Code
 SVC
 SDN



Tilting Wall Mount
 Order Code
 STV VESA up to 30"
 STN Non-VESA up to 25"



Column suspension unit with full swivel & tilt
 Use with any UNICOL ceiling or wall suspension equipment.
 Order Code
 SCV VESA up to 30"
 SCN Non-VESA up to 25"



Lectern style screen mount
 For use with touch screens or in show room displays. Tilt angle fully adjustable.
 Order Code
 SEV VESA up to 30"
 SEN Non-VESA up to 25"

These mounts fit all screens having either 75, 100 or 100 x 200 VESA fixing points. State LCD make & model when ordering.

Large VESA Range

For larger screen VESA fixing points:

- 200 x 200, 200 x 400, 200 x 600mm.
- 400 x 400, 400 x 600, 400 x 800mm.

VESA mountable screens up to 50inch.

State LCD / Plasma make & model when ordering.

 60kg MAX
 30-50" screens

Large VESA Tilting Mount

Order Code Black as standard colour
 PLW Up to 50" screens



Typical mount shown

ScreenTrac™

Multi-Display System for up to VESA 200 x 200mm

LCDs just slot on to wall plate. Use in sets to make up a multi-display system. MDC70 comes with 1 screen mount. MDC140 comes with 2 screen mounts. Additional screen mounting plates are available for multiple screen options. Comes with 1 padlock per screen mounting plate.

Order Code Black as standard colour
 MDC70 71cm unit complete
 MDC140 143cm unit complete
 MDM1 Flat mounting plate only



Typical MDC70 shown

 20-46" screens
 35kg MAX per screen

Optional security kit available – see Page 9.

PANARM™ LCD Wall Arm Mounts

EU Registered Designs 000371679-0001 & 000371679-0003

For LCD TV screens up to 30inch with VESA 75 x 75, 100 x 100 and 100 x 200mm or other fixings.

Allows viewing from any angle. Mount folds parallel to wall. 6cm folded (plus mount).

Comes complete with tilting mount that fixes to your screen.

Has built in tilt mechanism and rotation adjustment to level screen accurately in all positions.



Has Tilt, Swivel & Rotation *

* Slight rotation for levelling of screen



Single Swing Wall Mount

Order Code
 SRV VESA up to 30"
 SRN Non-VESA up to 25"

State LCD TV make & model

 35kg MAX
 15-30" screens



Double Swing Wall Mount

Order Code
 SSV VESA up to 30"
 SSN Non-VESA up to 25"

Colour choice Silver or Black
 Silver standard Black optional.
 (State colour choice when ordering)



The Universal Mount with Fingertip Tilt Control™

Imagine you could reach out and with a light touch, tilt your screen to the perfect viewing angle. The Pozimount Tilt Counterbalance Mechanism™ makes this possible – the angle you choose stays reliably set or can be changed whenever necessary.

Pozimount units adapt to fit most screens up to 50inch. They can be direct wall fixed or used with any of our ceiling kits, swing-arm wall units or stands & trolleys. A non-tilt version with the same screen fitting range is also listed.

Pozimount Tilt

Order Code	
PZWL	40" - 50" screens
PZWM	30" - 40" screens

Non Tilt Version

Order Code	
PZXL	40" - 50" screens
PZXM	30" - 40" screens

Please state Plasma / LCD model to enable us to include the correct fixing kit. We make Pozimounts in 2 ranges so that each mount is suited to the specific screen range size. The mounts are automatically supplied to fit the stated model of Plasma/ LCD unless otherwise requested.

Ceiling mount kits are also available – see Page 9
 State Plasma or LCD make & model

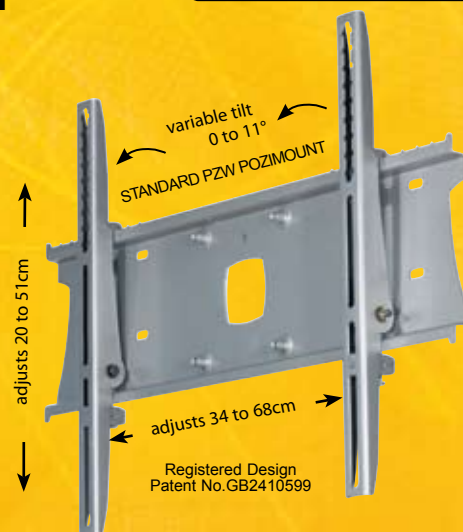

Approved Mounts which exactly match each Plasma / LCD listed

Colour choice Black
 Black is standard. Other colours available at extra cost – Call us for details



We offer a vast range of mounts covering all popular makes of Plasma / Large LCD TV. Each is designed to exactly match the screen fixing points and allow for cooling vents, cabling or features such as video card enclosures to ensure reliable and easy installation.

XACTMATCH mounts come in four versions:

- PLW – Landscape tilting wall, ceiling or stand mount.
- PLX – Landscape flat slimline wall or stand mount.
- PPW – Portrait tilting wall, ceiling or stand mount.
- PPX – Portrait flat slimline wall or stand mount.

Portrait & Landscape mounts are priced the same. Mounts can be direct wall fixed or used with any of our ceiling kits, swing-arm wall units or stands & trolleys detailed in this catalogue.



Tilting Mount

Order Code	
PLW1	Up to 50" screens
PLW2	51" to 65" versions
PLW3	66" to 80" versions
PLW4	81" and above

State Plasma or LCD make & model

Series 1	60kg MAX	30-50" screens	Series 2	85kg MAX	51-65" screens
----------	----------	----------------	----------	----------	----------------

For screens above 65", including 103", there is a range of specialist mounts - Please call for details.

Mounts to house computers, flash card readers and balun boxes are also available – see Page 9.

Slimline Mount

Slim profile, for 'close to the wall' appearance, where tilt is not required.

Order Code	
PLX1	Up to 50" screens
PLX2	51" to 65" versions
PLX3	66" to 80" screens
PLX4	81" and above

State Plasma or LCD make & model



Plasma Wall Arm Mounts

Colour choice Silver or Black
 Silver standard Black optional.
 (State colour choice when ordering)

Single Swing Wall Arm

For screens up to 50inch. Slim 6.5cm when folded flat (plus mount). Has built in tilt mechanism and rotation adjustment to level screen accurately in all positions.

Separate Pozimount or Xactmatch mount required to fix screen. (See above for these order details).



(State LCD TV make & model or VESA size if applicable)

Order Code	
PLS	Single Swing-Arm (Requires separate screen mount)

51inch & larger screen versions also available. – Call us for details.

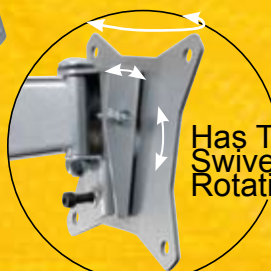

* Slight rotation for levelling of screen

Double Swing Wall Arm

For screens up to 50inch. Has 68cm of reach and greater articulation. Engineered for strength and ease of use. Arm conceals behind screen when folded to wall. Only 10.2cm when folded (plus mount). Has built in tilt mechanism and rotation adjustment to level screen accurately in all positions.

Separate Pozimount or Xactmatch mount required to fix screen. (See above for these order details).

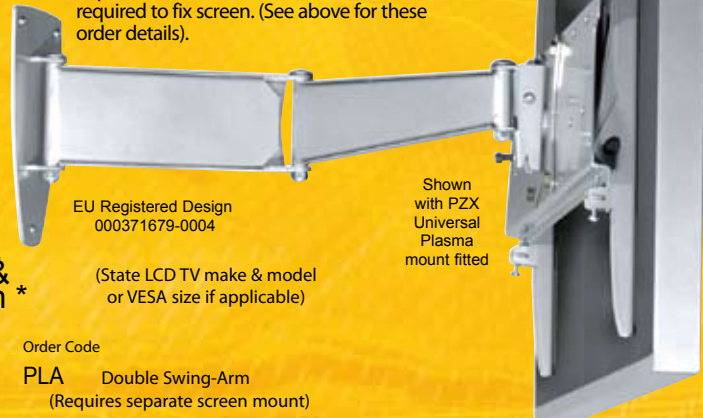

(State LCD TV make & model or VESA size if applicable)

Order Code	
PLA	Double Swing-Arm (Requires separate screen mount)

Colour choice Black
 Black is standard. Other colours available at extra cost – Call us for details

Standard Ceiling Plate

For suspension of projectors & single screens up to 50inch.



Order Code
CP1
 CP1E Extension

Large Ceiling Plate

For long column or heavy installations, single screens up to 65inch or twin 50inch screens.



Order Code
CP2

Peg Ceiling Plate

For direct connection of projectors & single screens up to 50inch.



Order Code
CP3

Tilting Ceiling Plate

For tilted suspension of projectors & single screens up to 50inch.



Order Code
CP6

Girder Clamps

Fully adjustable. For girders 7.5 to 25cm wide. Can tilt for use on sloping steel rafters.



Order Code
GC25
 Even wider span versions available.

CP2 Sandwich Plate

For use with CP2 ceiling plate. Comes with studding to clamp around girders or RSJ's.



Order Code
CP2P

Purlin Clamps

For single and double purlins. Has tilt facility.



Order Code
GCPS Single
GCPD Double

Pipe Mounts

Pipe mounts are available for pipes from 5 to 30cm diameter. – Call us for more details.

Typical mount for 30cm pipe shown.



Order Code
TM530
 Please state pipe diameter

RSJ Clamp

Use with RSJ's or structures that require large areas to clamp around.



Order Code
RSJM

Twin Column Ceiling Plate

For suspension of double screens up to 65inch.



Order Code
CP9

Tube Mounts

Model TM05 is used typically for suspending monitors from show stand or lighting structures.



Order Code
TM05 For 5cm tubes

Pillar Clamps

Pillar clamps are part of our range of specialist fittings, available in various sizes. – Call us for more details.



Order Code
VCC
 Typical Clamp shown for pillar diameter of 62cm
 Please state pillar diameter

Ceiling mount adapters for Pozimount and Xactmatch mounts listed on Page 7

Order the Single (or Back-to-Back) Mount Adapter then add Ceiling Plate, (or Girder Clamp etc) and column length required.

Single Mount Adapters

Adapts single Plasma / LCD mount for ceiling suspension.



Order Code
PS1 up to 50" screens
PS1L 51 to 65" versions

Back-to-Back Adapter

Combines two mounts for Back-to-Back ceiling suspension.



Order Code
PS1BBB
 Twin screens 51inch and above require heavy duty mounting. – Call us for details.

Twin Large Screen Installations

We advise the use of Twin Column suspension for all installations using Back-to-Back 51inch and larger Plasma screens, or single screens which may be subject to stress or wind loads.

– Call us for details of our ultra heavy duty mounts and accessories range.



Order Code
CP9
PS4

Column Coupler

Join columns with this concealed unit.

Code
CC

Trim Disc

Code
TD

Columns

(All have safety 'through bolt' holes at each end).

Code	Length
500	50cm
1000	1 metre
2000	2 metre
3000	3 metre

Multi-purpose Wall Brackets



Standard version for direct connection to any MSU or to our adapters. Arm 46cm to centre of peg.

Order Code
WB1

Suspension column version. Useful in many installation situations. Use with any of the columns listed above.

Order Code
WB2

Smaller version for direct connection to Projectors and medium LCD for screens up to 25kg. Arm 35cm to centre of peg.

Order Code
WB0

Wall Brackets with 55 or 60cm arms also available.
 Many other special versions manufactured – Call us for details.

Plasma / LCD Gantries & Rear Covers



We manufacture a range of specialist gantries, double, quadruple and more.

We also manufacture rear covers to hide cables and neaten appearance from the rear.

– Call us for details.

Video Conferencing Wall Mounts



Order Code
WBVC
 State camera make & model

Our standard platform unit can be fixed above or below any wall mounted Plasma or LCD screen.

We also manufacture versions designed for specific models of Video Conferencing Units.

– Call us for details.

Colour choice Black
 Black is standard. Other colours available at extra cost - Call us for details

Trade packs for Plasma screen and projector suspension

(Ceiling plate, Column & Mount w. tilt & rotation)

Offering ease and convenience for specifiers and installers. These 'packaged' kits combine the necessary ceiling plate, column and mount for a typical installation.

Three column lengths are available to suit differing ceiling heights.

Universal Single Screen Kit

Order Code	Column	Screen
KPL310CB	1m	27" to 37"
KPL320CB	2m	27" to 37"
KPL330CB	3m	27" to 37"
KPL110CB	1m	40" to 50"
KPL120CB	2m	40" to 50"
KPL130CB	3m	40" to 50"

Universal Twin Screen Kit

KPL310DB	1m	27" to 37"
KPL320DB	2m	27" to 37"
KPL330DB	3m	27" to 37"
KPL110DB	1m	40" to 50"
KPL120DB	2m	40" to 50"
KPL130DB	3m	40" to 50"

State screen make & model when ordering

Package consists of Ceiling plate, Column & Mount with tilt and rotation function.



Universal Ceiling Mount Plasma Kit



Ceiling Mount Back-to-Back Plasma Kit



Universal Projector Kit

For projectors up to 12kg.

Order Code	Column
KPR110CB	1m
KPR120CB	2m
KPR130CB	3m



State projector make & model when ordering

- for heavier projectors see other ceiling mounts on Page 11

Universal Ceiling Mount Projector Kit



Multi-Device Units

We offer a wide range of options for mounting twin or multiple projectors, LCD or Plasma screens. Ideal for shop fronts, financial institutions, control rooms, museums and art galleries.

These can be floor to ceiling, trolley, desk, or ceiling mounted with screens presented either flat or angled.

- Call us for details.

Projector stacker units are made for each specified projector.

Modular design enables units to be stacked one on top of the other.



Desk top multi-screen units

available in several versions.

Modular design allows units to be adapted to suit different applications.



Floor to Ceiling Units



Popular in shop fronts, screens can be adjusted to butt together.

Alternative single and double base plates and ceiling plates available. On single columns use EPSV to mount VESA 75 to 100 x 200mm screen fixings. For larger screens use PS7T plus screen mount. Please call us for details.

Plasma mount Security Kit



Standard Wall mount Security Kit shown

Use this easily fitted Security Kit with any of our plasma or large LCD mounts. Use with both flat & tilting versions.

The 220cm tough steel cable system has special fittings which shield access to the screen fixing screws.

Versions for Stands & Trolleys also available.

Order Code PSK

Plasma Mount housings for computer, flash card or balun boxes

Specialist Plasma / LCD mounts incorporating a housing for slim-line computer, flash card reader or balun box. Power sockets can also be built in. These interface units can reduce installation time.

Universal mount and security locking versions available.

- Call us for details.

New components we have not yet covered will need to be sent to our factory in order to design the mount.



Samsung Q1 mount

Fixes to wall or bulkhead.

Universal wall or trolley mount version shown with small form factor.

LCD Outdoor Housing

Housings to IP53 rating have 6mm thick clear anti-shatter screen protection. Standard unit fits 40 to 46inch LCD screens, other screen sizes to special order.



Front screen designed to neatly frame LCD screen area.

Units can allow normal remote operation or have IR port covered as required.

Can be supplied for wall or ceiling mounting.

Standard unit fits 40 to 46inch screens.

Order Code ODH

State LCD model when ordering

RemoGuard™ Locking Remote Control Holders



RemoGuard holders not only deter against the loss, theft or damage of remote control units but overcome the problem of hard wiring to control projectors or other AV equipment.

Simply fix the unit to any wall or other line of sight surface and the reflected IR beam projects horizontally to allow normal operation.

Order Code RGH Colour White

Fits most Remote Control Units
 RGH1 version available for larger remotes

Screen Protection Units



6mm thick clear anti-shatter screen framed by a metal bezel completely covers Plasma / LCD front. Units for all screen makes. 5mm Anti-glare screen can be provided on request (surcharge).

Order Code PCL up to 50"
 PCS 51 to 65"

State Plasma / LCD model

GYROLOCK® – Mount for Projectors up to 12kg

Colour choice Black
 Black is standard. Other colours available at extra cost – Call us for details

Installation friendly – use GK1 mount any way up, ceiling, wall or base fixable.
 Telescopic – use through suspended ceilings or in high, low or normal headroom situations.
 Trilok® Docking System allows easy projector installation – just twist & lock in position.
 Tilt or turn your projector through any angle for easy, precise screen set up.



Gyrolock has undergone stringent independent testing to meet these international approvals.

GYROLOCK®

These products are the subject of UK and USA design rights.
 UK Registered Design 3011575.
 UK Trade Mark 2244062.
 US Patent 10/049390.

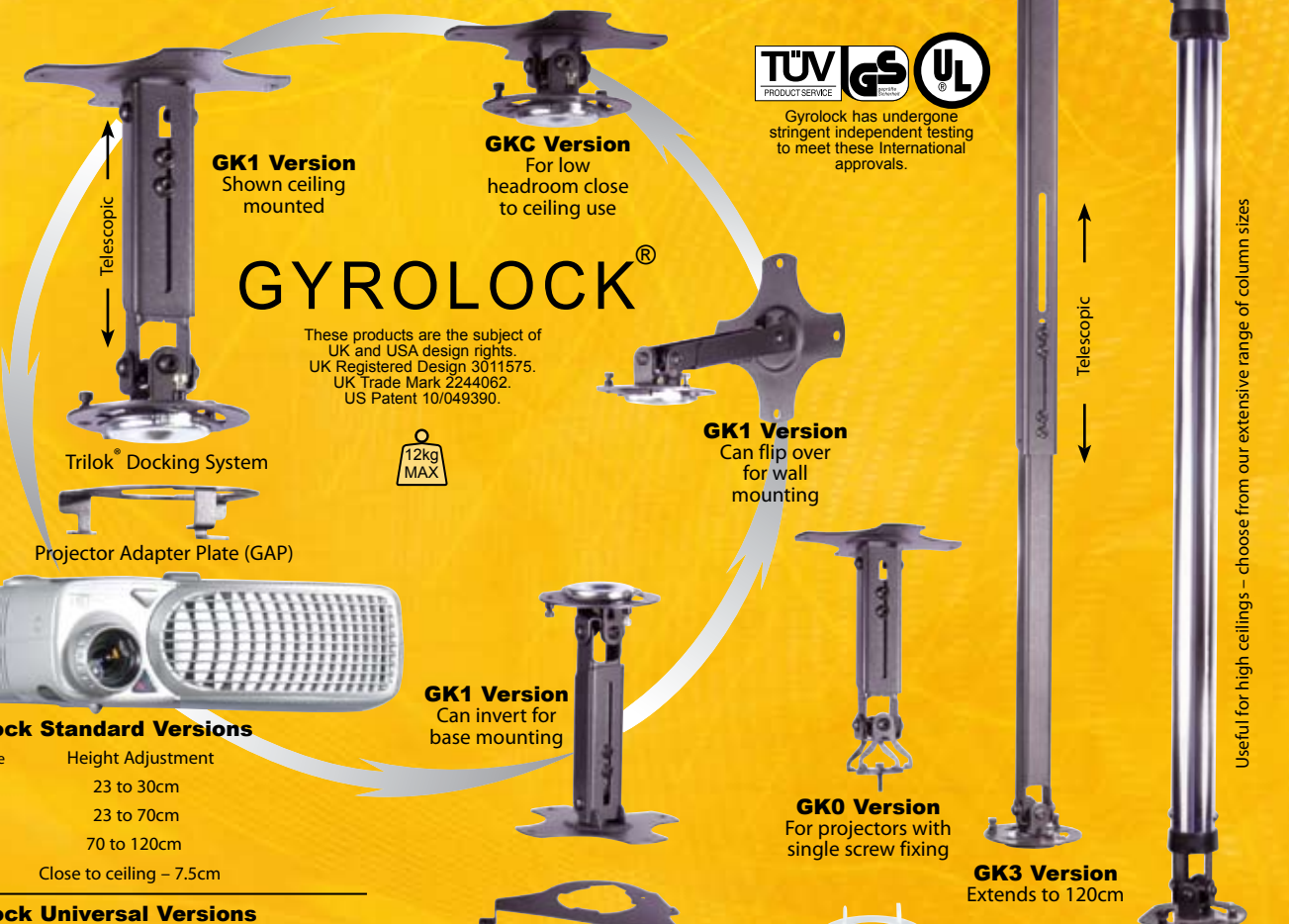

Gyrolock Standard Versions

Order Code	Height Adjustment
GK1	23 to 30cm
GK2	23 to 70cm
GK3	70 to 120cm
GKC	Close to ceiling – 7.5cm

Gyrolock Universal Versions

Order Code	Height Adjustment
GKUX	12cm fix
GKU1	23 to 30cm
GKU2	23 to 70cm
GKU3	70 to 120cm

Gyrolock for Single Screw Projectors

GK0 23 to 30cm
 (For small projectors with a single centre fixing screw).

Gyrolock for Column Adaption

GK4 Gyrolock for column mounting (with GAP)
 (Needs CP1 Ceiling Plate & column length to complete unit).

Projector Adapter Plates

GAP	Adapter plate only
UGAP	Universal plate only

All Gyrolock versions come complete with the GAP (projector adapter plate) or Universal adapter plate UGAP. Colour Black.

How to Order

Select the Gyrolock best suited for your needs. State projector make & model (unit comes with projector fixing screws and adapter plate).

Note: GK4 version needs Ceiling Plate & Column.



Adapter Plate
 Order Code GAP



Trim Disc
 Ceiling finisher
 Order Code GKTD



Universal Adapter Plate
 Order Code UGAP
 EU Registered Design 000221072-0001



GKX Home Cinema Version

GYROLOCK for Home Cinema

Order our Compact GKX version for home projection. Easy installation. Full tilt and turn adjustment. Complete with adapter plate to suit your projector.

Colour Silver

Order Code GKX

Includes adapter plate.

State projector make & model when ordering

TETHERLOC® Anti-theft Kit

Add this easily fitted kit when you order your Gyrolock mount unit.

The tough steel cable system has special fittings which shield access to the projector fixing screws and link the mount and projector to the ceiling fixing bolts. (Access to the ceiling bolts is also shielded by the special locking unit).

Standard, medium or long cable sets are available for the following Gyrolock versions.

Order Code	
GT40	Tetherloc for GK1 (40cm cables)
GT80	Tetherloc for GK2 (80cm cables)
GT130	Tetherloc for GK3 (130cm cables)



Colour choice Black
 Black is standard. Other colours available at extra cost – Call us for details

PSU™ Series Mounts for all Single Lens Projectors

Our PSU (Projector Suspension Unit) range covers all makes of projectors. Each mount is specifically designed for the model listed, supporting the projector either inverted or in a cradle according to manufacturers' recommendations.

All mounts have full swivel and tilt for easy positioning. Cables can be hidden within columns. Trim Discs provide a neat finish where columns pass through suspended ceilings. Very large projectors used typically in conference auditoriums require special heavy duty mounts which we also manufacture – Call us for details.

How to Order

Select your projector mount, Ceiling Plate, Column or other items from the components listed. State projector make & model when ordering.

PSU Video Projector Mounts

Order Code
PSU For any projector listed up to 45kg
 State projector make & model when ordering

Ceiling Plates & Wall Brackets

See Page 8 for a complete list of all Ceiling Plates, adapters and Wall Brackets.

CP1 Standard – supports up to 60kg
 CP3 Low Headroom Peg Version
 CP6 Tilting Ceiling Plate
 WB0 Wall Bracket (projectors up to 25kg)

Columns & Accessories

500 50cm Column
 1000 1 metre Column
 2000 2 metre Column
 CC Column Coupler
 TD Trim Disc Ceiling Finisher (white)



Standard inverted mount

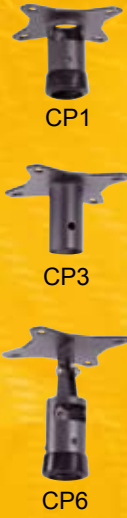

CP1

CP3

CP6



WB0



CC

TD

All suspension columns have safety 'through bolt' holes. Special column sizes available. (See Page 15)

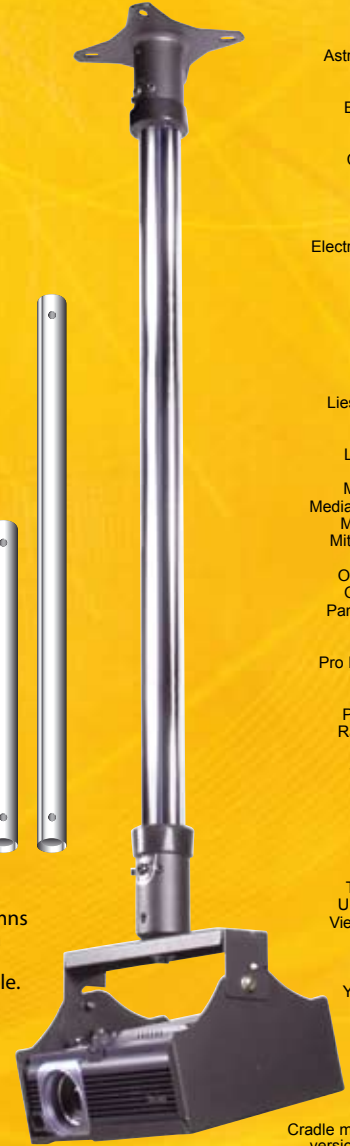

Cradle mount version

- ADI
- Ask
- Astrobeam
- Barco
- Benq
- Boxlight
- Canon
- Casio
- Christie
- Dell
- Delta
- Eiki
- Eizo
- Electrohome
- Epson
- Fujitsu
- Hilight
- Hitachi
- HP
- Iiyama
- Infocus
- JVC
- Liesegang
- LG
- Litepro
- Lumens
- 3M
- Marantz
- Media Vision
- Microtek
- Mitsubishi
- NEC
- Olympus
- Optoma
- Panasonic
- Philips
- Plus
- Pro Display
- Project
- Prolite
- Proxima
- Rapesco
- Reflex
- Sahara
- Sanyo
- Saville
- Seleco
- Sharp
- Sim2
- Sony
- Toshiba
- Ultralight
- Viewsonic
- Vibrant
- Vision
- Vivitar
- Yamaha

GUARDBOX® Anti-theft Enclosures

Constructed from heavy gauge steel and incorporating many innovative features.

Five sizes are available covering a wide range of projectors. Each Guardbox incorporates our unique twin bar system, designed to fit into a number of slots for different projector lens positions. Each bar has another bar fitted inside making it virtually impossible to hacksaw through.

As a further aid to security our 'Taglock' Kits are available to provide secondary locking. We also recommend the use of our Locking Ceiling Plate Covers, CPSC1 which shield the Ceiling Plate from unauthorised removal.

Guardboxes & Accessories

Order Code	Projector max. size inc. cables width depth height
PGY	25 x 25 x 10cm
PGX	36 x 34 x 14cm
PGS	36 x 44 x 14cm
PGM	46 x 44 x 16cm
PGL	36 x 54 x 18cm

TLK Taglock Kit

CP1 Standard Ceiling Plate

CPSC1 Locking Ceiling Plate Cover

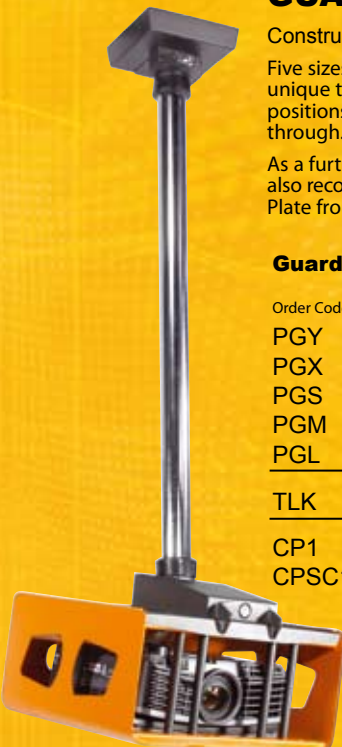

PGX
(Shown in orange)



PGM Guardbox shown

CP1 & CPSC1
 Standard Ceiling Plate with Locking Cover shown.



Taglock Kit



Anti-theft Alarm

Key operated 110dB power supply interrupt and motion sensor alarm. Can be fixed with glue provided to any device.

Order Code
AKS1

Select column lengths from list above.
 Special column lengths also available. (See Page 15).

Colour Silver/Black/Orange

How to Order

Check your projector size, allowing room for cables. Choose a Guardbox from the list of sizes shown above. Select Column and Ceiling Plate most suited for your installation. Add the Taglock Kit and Locking Ceiling Plate Cover if required.

Colour choice Black
 Black is standard. Other colours available at extra cost – Call us for details

- Aiwa
- Akai
- Albiral
- B&O Beko
- Bush
- Daewoo
- Decca
- Ferguson
- Finlux
- Goldstar
- Goodmans
- Grundig
- Hantarex
- Hitachi
- Ilyama
- JVC
- LG
- Loewe
- Matsui
- Mitsubishi
- NEC
- Orion
- Panasonic
- Philips
- Samsung
- Sanyo
- Selfi
- Seleco
- Sharp
- Sony
- Tatung
- Thomson
- Toshiba
- Vista
- Viewsonic
- Vutrix
- and many others

Our MSU range of professional ceiling and wall mounts currently stands at over 2,000 models, each one individually designed to match the television or monitor listed.

All have clean uncluttered lines and are designed for easy, safe and rapid installation with full adjustment for swivel and tilt.

Power, signal & safety cabling can be hidden within the suspension column for neat appearance.

Order Code
MSU Standard MSU Unit
29" TV Monitors & larger

State TV make & model

Adjustable brackets for VCR / DVD are also available for direct fitting to all MSU mounts.

Order Code
B2 Adjustable VCR / DVD Bracket

How to Order

Select your MSU mount, Ceiling Plate, Column or other items from the components shown on Page 8. State make & model of TV when ordering.



Standard MSU Unit

Custom TV Wall Mount Range

For all makes of television receivers and monitors. These quality engineered mounts are designed to combine neat appearance with safe, easy installation.

State TV make & model when ordering



Typical mounts shown

WCE

360° swivel



MSU with adjustable VCR / DVD bracket

COMPACT For up to 21" screen televisions

Order Code
WCS Standard Level mount
WCE Angled 10 degrees

HEAVY DUTY (Up to 29" screen televisions)

Order Code
WBS Standard Level mount



Typical board and projector shown. Boom length at minimum.

Height adjustable

WHITEBOARD PROJECTOR STAND

This floor standing unit must be bolted to the wall for stability of the boom, extendable from 130cm to 220cm. The stand is height adjustable and can adapt to larger sizes of Whiteboard. It has removable cable management panels and combines neat appearance with safe, easy installation. Comes with a universal projector mount suitable for short throw projectors.

Order Code
WPS For up to 84" screens

MOTORISED TROLLEYS AND MOUNTS

UNICOL PowaLift™

For Plasma / LCD where the screen needs to be easily moved between low and high positions.

These electrically operated mounts allow a Plasma or LCD screen to be raised or lowered using a remote control.

For many applications where flexibility in use is required, such as teaching small children utilising interactive screen overlays or working with wheelchair users who need to interact with the screen.

Trolley comes with full cable management. Lockable boxes are available for Laptops and DVDs.

For screens with overlays up to 55". Length of powered travel is 600mm.

– Call us for details.

PowaLift Trolley

Order Code
AVMT
 (State screen make & model)



PowaLift Wall Mount

Order Code
AVMW
 (State screen make & model)



Powered up & down

Maximum height to centre of screen 167cm

Powered up & down

Colour choice Black
 Black is standard. Other colours available at extra cost - Call us for details

Twin column cantilever design chosen by commercial video users everywhere. Wide selection of component parts enables stands & trolleys of varying types to be easily assembled.



Shown with interactive white board & glass shelf

AV users regard VS1000 stands & trolleys as the 'work horse' of the industry.

With their wide choice of interchangeable parts, easy assembly and sheer robustness, these units continue to be the favoured choice of trade show, broadcast and other users.

For the education market there are adapters available for Interactive Whiteboards.

Glass or metal shelves are available along with locking cabinets and video conferencing platforms.

How to Order

Choose from the stand or trolley versions shown or select the separate parts for your needs. Screens 51 - 65" require heavy-duty mounts (surcharge).



Height to centre of screen 153cm

Registered design

This stand is also available with split columns - ideally suited for exhibitions! We offer flightcases, too.

State Plasma / LCD make & model

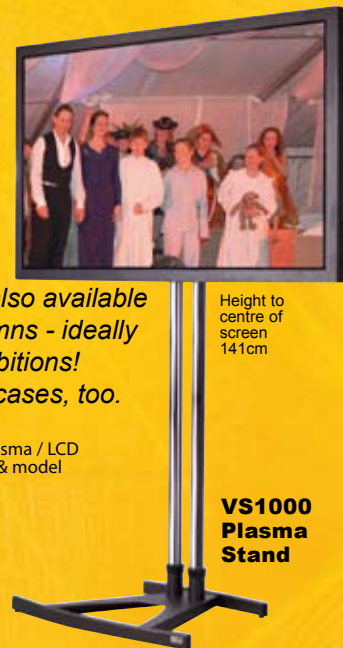

Height to centre of screen 141cm

VS1000 Plasma Stand

Order Code VSX/592/PS2/PLW

VS1000 Plasma Trolley

Order Code VSS/592/PS2/PLW

Television Mounts

We list a vast and ever growing range of mounts for televisions & monitors:

- Aiwa
- Akai
- Albiral
- B&O
- Beko
- Bush
- Daewoo
- Decca
- Ferguson
- Fidelity
- Finlux
- Ganz
- Goldstar
- Goodmans
- Grundig
- Hantarex
- Hitachi
- Iiyama
- JVC
- LG



Typical mount shown

Order Code VMS TV mount
 State TV make & model

- Matsui
- Mitsubishi
- NEC
- Orion
- Panasonic
- Philips
- Samsung
- Sanyo
- Selti
- Selec
- Sharp
- Sony
- Tatung
- Thomson
- Toshiba
- Vista
- Viewsonic
- Vutrix
- and others

Equipment Platforms

General purpose - for video recorders, DVD players or other equipment. Fully height adjustable. VP1 to VP3 support up to 30kg. VGS supports up to 20kg.



VGS has high quality fully edge polished 8mm toughened glass. Conforms to BS 6206 Class A.

Order Code	Size cm
VP1	40 x 50
VP2	45 x 55
VP3	30 x 30
VSGS	40 x 50 (Glass)

Plasma / LCD Trolley Mounts

Models listed for all makes of Plasma & LCD TV screens.

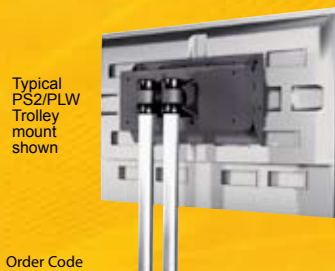

Typical PS2/PLW Trolley mount shown

Order Code PLW Mount only - State Plasma / LCD model
 PS2 Trolley Twin Socket Adapter
 (PS2 & PLW together make up the complete trolley mount).
 - Other Plasma / LCD TV mounts listed on Page 7.

Video Locking Cabinet

Fully height adjustable. Access for mains and other cables.

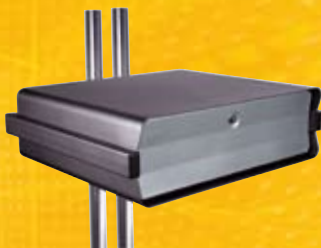

45kg MAX

Order Code VLC
 Inside dimensions cm
 55 wide x 40 deep x 15 high

Columns (Pairs)

Add 15cm to these column lengths to calculate assembled height with trolley base.

Order Code	Length cm
352	89
452	114
552	140
592	150

Special column lengths also available - see parts & accessories Page 15.



Video Conferencing Mounts

Standard platform unit fits above Plasma or LCD screen. Use standard shelf when fitting below screen.

Other units available to fit specific Video Conferencing models.

- Call us for details.



Unit fits behind Plasma or LCD. Can be extended to suit different screen sizes.

Order Code VCM
 State Video Conferencing Unit when ordering.
 Platform size 26 x 34cm

Original 'K' Bases

With non-marking rubber wheels.



Braked wheel option

80kg MAX

Order Code VSB Wheeled Base 60 x 87
 VBR with BRAKED wheels
 VBR base has higher spec wheels - supports up to 105kg

SCIMITAR™ Bases

Elegant curved design provides modern styled alternative to original 'K' base. Wheeled or free-standing versions.

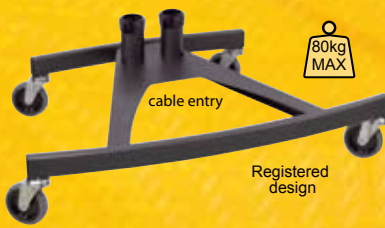

80kg MAX

Registered design

Order Code VSS Wheeled Base 60 x 87
 VSR with BRAKED wheels
 VSX Free-standing version

Compact Bolt Down Base

For shop fitting and display applications or any permanent installation where a minimal base size is required.

Design allows floor bolts to be neatly recessed. Trim caps are supplied to cover the bolt recesses.

Single column versions available.

Corner holes are sized for M12 fixing bolts.



Order Code VSF
 Size cm 25 x 39

High strength floor fixing bolts suitable for the installation must be specified for this product.

Colour choice Black
 Black is standard. Other colours available at extra cost – Call us for details

The standard trolley for educational television. Many thousands in daily use in schools, colleges, universities, hospitals and training organisations.



TC1000 Trolley for Plasma TV

Order Code
 TCB/322/TPS/TPH
 State Plasma make & model



Video Cabinet Trolley

Shown with TMS top for TV

Height 99cm

Order Code
 TCB/322/TMS/TLC
 State TV make & model

Freestanding Cabinet Unit



The AVR2 Cabinet Unit is designed for use with the single screen Avecta Hi-level Trolley mast system. It can also be used on its own as a freestanding unit. The unit has braked castors, three adjustable shelves and a clear poly-carbonate panel in the door.

Order Code
 AVR2

See Page 2 for Avecta base version

Plasma and LCD Mounts

In addition to our vast range of mounts for televisions and monitors we now provide a Universal Mount for Plasma and LCD screens.

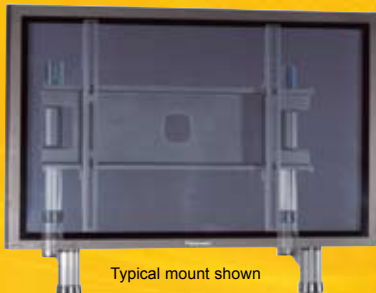

Typical mount shown

Order Code
 TPS Plasma mount
 State Plasma make & model

Equipment Platforms

General purpose – for VCR / DVD or other AV or IT equipment.

Top platform units



Order Code	Size cm
TPX	45 x 75
TPZ	45 x 90

Lower platform units



Order Code	Size cm
TPH	33 x 55
TPC	45 x 55
TPK	55 x 55



TOPFIX™ Cabinet

Has a useful top surface suitable for a variety of purposes and can be drilled (or supplied pre-drilled) for direct fixing of televisions, screw heads being inaccessible when cabinet is locked.



Useable top area of cabinet
 70 x 47cm



Order Code
 TLX
 Inside dimensions cm
 60 wide x 40 deep x 12 high

Trolley Bases

With non-marking rubber wheels.



(TBS base for assembly of school TV trolleys to BS7429)



Order Code
 TCB
 TBS
 Size cm
 Wheeled Base 66 x 78
 Wheeled Base 71 x 101

Columns (Pairs)

Add 18cm to these column lengths to calculate assembled height with trolley base.

Order Code	length cm
322	81
402	102
452	114

Special Column lengths also available – see parts & accessories Page 15.

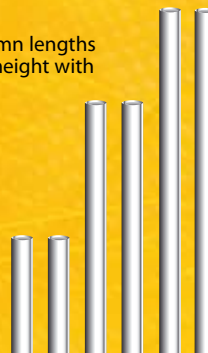

Video Locking Cabinet

Fully height adjustable. Access for mains and other cables.



Order Code
 TLC
 Inside dimensions cm
 55 wide x 40 deep x 15 high

4-Way Power Sockets

These clip to the base of TC1000 trolleys and Single Column Trolleys on Page 15.

Available for VS1000 trolleys on Page 13.

Units have 4m cable.

UK version shown.



Order Code
 ES04E (Europlug)

Internal Locking Bracket

Easy to install – provides an additional deterrent against equipment theft.



Fits TLC, VLC and Bench or Wall Cabinets.

Order Code
 LB475
 Inside dimensions cm
 47.5 wide x 14 high

Bench or Wall Cabinet

A security aid for VCR / DVD, computers or other equipment. Can be fixed to work surfaces or load bearing walls. Has full cable access.



Order Code
 BWLC
 Inside dimensions cm
 55 wide x 40 deep x 15 high

Peter Ligertwood evolved the unique system of interchangeable AV support components now in almost 45 years of continuous production and still the Industry Standard.

Colour choice Black
 Black is standard. Other colours available at extra cost - Call us for details

UNICOL

Birth of the Brand:
 Uni - Single
 Col - Column



Shown with long telescopic column, shelf for Lap-top & shelf for projector



Shown with short telescopic column, shelf for Codec, VESA mount and Video Conferencing camera shelf



Telescopic Trolley
S/3350/AD/PA

Projector Trolley
S/45/PB

Telescopic Trolley
S/3341/AP/VVC

Lectern
MG/45/PE

General Purpose Trolley
M/24/PB

Platforms

In a range of useful sizes.



Order Code	Size cm
PA	30 x 45
PB	45 x 45
PC	45 x 55
PF	30 x 75

Lectern Platform

Fixed reading angle of 15 degrees.



Order Code	Size cm
PE	45 x 45

Tilting Platforms

Fully adjustable from level to 10 degrees.



Order Code	Size cm
TGA	30 x 45
TGB	45 x 45
TGC	45 x 55

Standard Columns

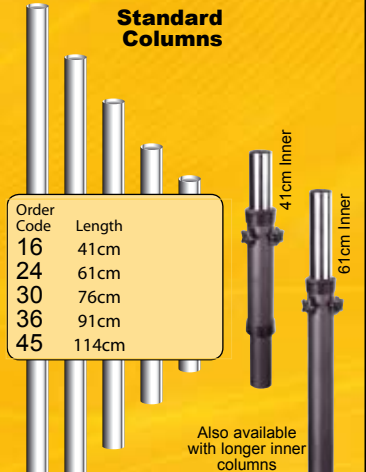

Order Code	Length
16	41cm
24	61cm
30	76cm
36	91cm
45	114cm

Accessory Platforms

Fully height adjustable.



Order Code	Size cm
AP	30 x 30
AD	40 x 40

Bases

MG Base has Static Feet.



Order Code	Size cm
M	40 x 40
MG	40 x 40

Bases with Jacking Feet



Order Code	Size cm
S	45 x 55
L	55 x 65

Telescopic Columns

Order Code	Trolley height range
2533	64 to 85cm
3350	84 to 128cm
4872	122 to 183cm

PARTS & ACCESSORIES

5cm Castor

Single Column trolley range.



Order Code: 5CMCASTOR

Hand Wheel



Order Code: HW38F

Socket Cap



Order Code: SC

7.5cm Braked

Avecta & Axia: 2 braked/ 2 unbraked



Order Code: 7CMCASTORKIT

10cm Castor

Avecta & Axia no-cost option when ordering

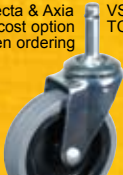

Order Code: 10CMCASTOR

10cm Braked



Order Code: 10CMBRAKED



Order Code: SPB Black, SPS Silver

Touch-in Paint

Specially formulated to match Unicol Sinterflex Black and Diamond Silver.

Large size can - 400ml.

Grub Screw



Order Code: GRUBSCREW

Allen Key

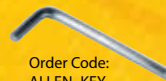

Order Code: ALLEN_KEY

Fits Grub Screws & Through bolts. (Other Allen Keys available).

Through Bolt



Order Code: TBT

Replacement Lock & Keys



Order Code: RLK

UNICOL Columns

Lengths to customers' special requirements. - Call us for details.

* Columns with safety 'through bolt' holes must be specified if used for suspension applications.

We offer colour finished and even stainless steel columns - Call us for details.



Complex and demanding gantry solutions



Single column installation with special restraining bar



One of many Pillar clamp options available



Very high ceiling installations



Specialised indoor and outdoor housings

Flat screen advertising, information or entertainment using LCD, Plasma or Projectors is now commonplace in stores and public areas. We lead the field in providing installation hardware for airports, supermarkets and shopping malls, pubs, clubs, and gymnasiums and many more.

UNICOL has been at the forefront of developing easy to use and cost effective mounting solutions where cable management and provision for IT hardware such as PC and Balun boxes are given equal priority to the more obvious needs of height adjustment, swivel and tilt. Completed installations blend neatly with store interiors to present a high degree of aesthetic appearance.

In-store mounting options include a range of special adapters designed to fit existing retail shelving schemes (see illustration), anti-tamper front and rear covers and many other specialist items. All products are extensively tested to guarantee safe mounting in public areas.



In-store marketing at Point Of Sale with LCD screens adapted to shelving and Plasma suspended overhead

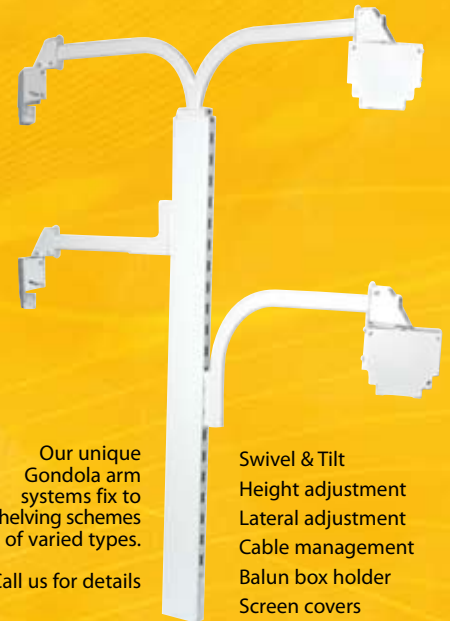

Our unique Gondola arm systems fix to shelving schemes of varied types.
Call us for details

Swivel & Tilt
Height adjustment
Lateral adjustment
Cable management
Balun box holder
Screen covers

UNICOL can provide expertise, sample products, prototyping and assistance with hardware selection for all these applications – Call us without obligation.

OUR SERVICE

We offer you:

- top quality products
- technical consultation
- over 55.000 different products

CONTACT US

Web: www.tracor-europe.fr
Tél: 01.60.91.42.49
Fax: 01.60.91.42.20
Email: infocom@tracor-europe.fr

TRACOR EUROPE
1 allée de la chartreuse
91020 Evry cedex